



LIENBACHER

By **J.P. VOS** 
HI THERM PRODUCTS S.P.A.

ACCESSOIRES



CATALOGUE- CATALOGUS 2014 / 2015



INDEX

<u>PLAQUE DE SOL EN VERRE TREMPE 8 mm, AVEC 20 mm chanfrein</u>	P. 01
<u>BESCHERMINGSPLAAT IN GEHARD GLAS 8 mm , 20 mm schuine kant</u>	P. 01
<u>PLAQUE DE SOL EN VERRE TREMPE 8 mm, AVEC 20 mm chanfrein</u>	P. 02
<u>BESCHERMINGSPLAAT IN GEHARD GLAS 8 mm , 20 mm schuine kant</u>	P. 02
<u>PLAQUE DE SOL EN VERRE TREMPE 1.5mm</u>	P. 03
<u>BESCHERMINGSPLAAT IN GEHARD GLAS 1.5 mm</u>	P. 03
<u>PLAQUE DE SOL EN VERRE TREMPE 1.5 mm</u>	P. 04
<u>BESCHERMINGSPLAAT IN GEHARD GLAS 1.5 mm</u>	P. 04
<u>PLAQUE DE SOL EN VERRE TREMPE 1.5 mm</u>	P. 05
<u>BESCHERMINGSPLAAT IN GEHARD GLAS 1.5 mm</u>	P. 05
<u>SERVITEUR –ACCESSOIRES</u>	P. 06
<u>HAARDSTEL –ACCESSOIRES</u>	P. 06
<u>SERVITEUR –ACCESSOIRES</u>	P. 07
<u>HAARDSTEL –ACCESSOIRES</u>	P. 07
<u>SERVITEUR –ACCESSOIRES</u>	P. 08
<u>HAARDSTEL –ACCESSOIRES</u>	P. 08
<u>PARE-FEU</u>	P. 09
<u>HAARDSCHERM</u>	P. 09
<u>PANIER A BOIS - CHARBONNIERE</u>	P. 10
<u>HOUTMANDEN - KOLENGIETER</u>	P. 10
<u>PANIER</u>	P. 11
<u>MANDEN</u>	P. 11
<u>PELLE - SEAU A CENDRE</u>	P. 12
<u>SCHEP - ASEMMERS</u>	P. 12
<u>BOUILLOIRE - DESHUMIDIFICATEUR - ASPIRATEUR - COMBUSTIBLE</u>	P. 13
<u>KOKER—SATURATEUR—STOFZUIGER—BRANDSTOF</u>	P. 13

PLAQUE DE SOL EN VERRE TREMPE 8 mm, AVEC 20 mm chanfrein

BESCHERMINGSPLAAT IN GEHARD GLAS 8 mm, 20 mm schuive kant

<u>DIMENSION / AFMETING</u>	<u>REFERENCE / REFERENTIE</u>	<u>PRIX / PRIJS (Htva/Excl Btw)</u>
100 x 120 x 0,8 cm	21.02.880.2	85 p
100 x 100 x 0,8 cm	21.02.881.2	85 p
80 x 80 x 0.8 cm	21.02.897.2	85 p
120 x 130 x 0.8 cm	21.02.886.2	85 p
100 x 110 x 0.8 cm	21.02.885.2	85 p
100 x 120 x 0.8 cm	21.02.882.2	85 p
100 x 110 x 0.8 cm	21.02.887.2	85 p

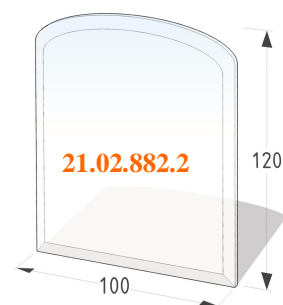
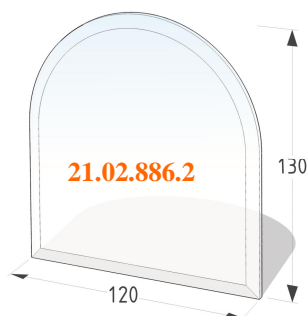
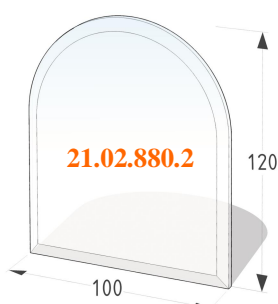

<u>DIMENSION / AFMETING</u>	<u>REFERENCE / REFERENTIE</u>	<u>PRIX / PRIJS (Htva/Excl Btw)</u>
Diam. 100	21.02.878.2	85 p
120 x 105 x 0.8 cm	21.02.883.2	85 p
85 x 110 x 0.8 cm	21.02.981.2	85 p

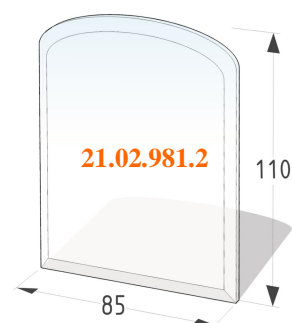
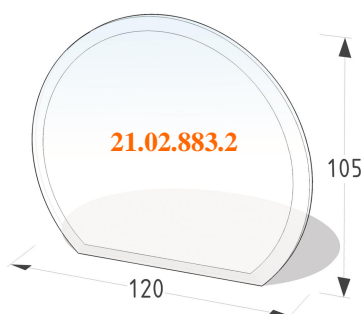
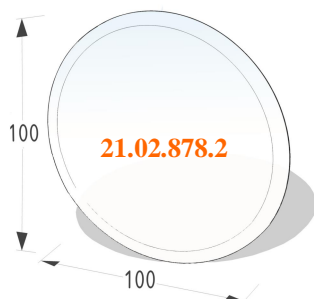

PLAQUE DE SOL EN VERRE TREMPE 8 mm, AVEC 20 mm chanfrein

BESCHERMINGSPLAAT IN GEHARD GLAS 8 mm, 20 mm schuive kant

<u>DIMENSION / AFMETING</u>	<u>REFERENCE / REFERENTIE</u>	<u>PRIX / PRIJS (Htva/Excl. Btw)</u>
100 X 120 X 0.8 cm	21.02.889.2	85 p
110 X 110 X 0.8 cm (57.2 X 57.2 X 0.8 cm)	21.02.982.2	85 p
125 X 125 X 0.8 cm (65 X 65 X 0.8 cm)	21.02.983.2	85 p

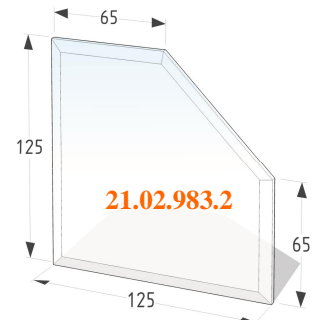
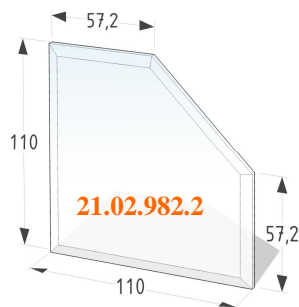
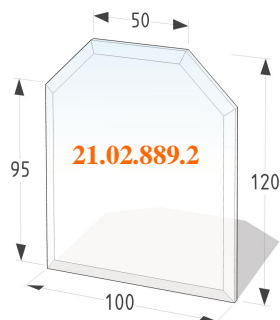

<u>DIMENSION / AFMETING</u>	<u>REFERENCE / REFERENTIE</u>	<u>PRIX / PRIJS (Htva/Excl. Btw)</u>
110 X 110 X 0.8 cm (55 X 55 X 0.8 cm)	21.02.884.2	85 p
125 X 125 X 0.8 cm (65 X 65 X 0.8 cm)	21.02.888.2	85 p
100 x 100 x 0.8 cm	21.02.894.2	85 p
80 x 80 x 0.8 cm	21.02.893.2	85 p
100 x 120 x 0.8 cm	21.02.895.2	85 p
90 x 75 x 0.8 cm	21.02.898.2	85 p

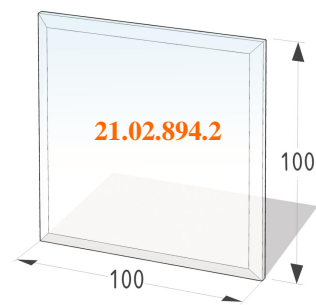
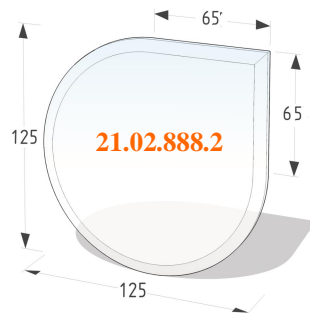
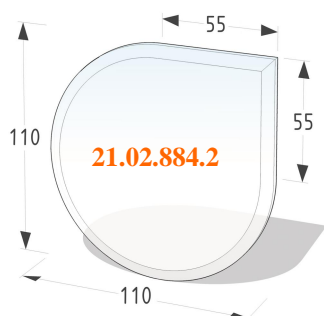

PLAQUE DE PROTECTION 1.5 MM (EPOXY ANTHRACITE / EPOXY NOIR)

BESCHERMINGSPLAAT 1.5 MM (antraciet epoxy / zwart epoxy)

<u>DIMENSION / AFMETING</u>	<u>REFERENCE / REFERENTIE</u>	<u>PRIX / PRIJS (Htva/Excl. Btw)</u>
Diam. 100 (Anthracite/ Antraciet)	21.02.198.2	179 p
Diam. 100 Noir/Zwart)	21.02.298.2	187 p

80 x 80 (Anthracite/Antraciet)	21.02.193.2	121 p
80 x 80 (Noir/Zwart)	21.02.293.2	107 p

100 x 100 (Anthracite/ Antraciet)	21.02.194.2	115 p
100 x 100 (Noir/Zwart)	21.02.294.2	115 p

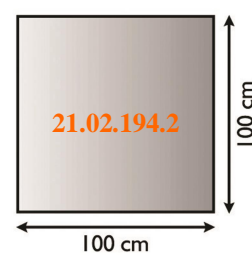
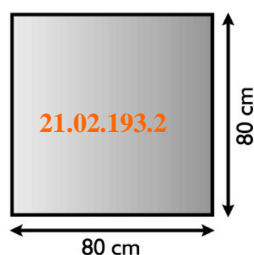
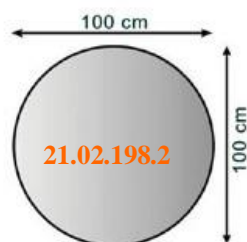

<u>DIMENSION / AFMETING</u>	<u>REFERENCE / REFERENTIE</u>	<u>PRIX / PRIJS (Htva/Excl. Btw)</u>
120 x 130 (Anthracite/ Antraciet)	21.02.186.2	195 p
120 x 130 (Noir/Zwart)	21.02.286.2	195 p

100 x 120 (Anthracite/ Antraciet)	21.02.180.2	161 p
100 x 120 (Noir/Zwart)	21.02.280.2	161 p

100 x 120 (Anthracite/ Antraciet)	21.02.182.2	161 p
100 x 120 (Noir/Zwart)	21.02.282.2	161 p

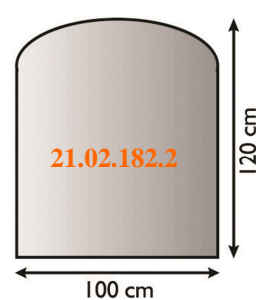
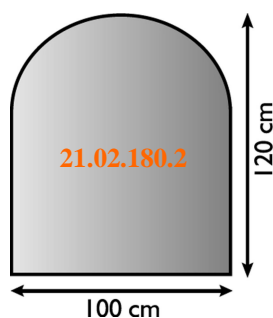
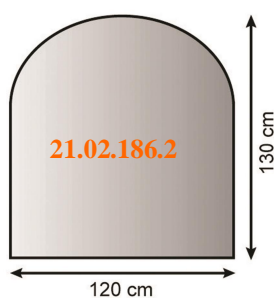

PLAQUE DE SOL ACIER 1.5 MM (EPOXY ANTHRACITE / EPOXY NOIR)

BESCHERMINGSPLAAT 1.5 MM (antraciet epoxy / zwart epoxy)

<u>DIMENSION / AFMETING</u>	<u>REFERENCE / REFERENTIE</u>	<u>PRIX / PRIJS (Htva/Excl. Btw)</u>
85 X 110 (Anthracite/Antraciet)	21.02.181.2	85 p
85 x 110 (Noir/Zwart)	21.02.281.2	85 p

125 x 125 (Anthracite/Antraciet)	21.02.188.2	105 p
125 x 125 (Noir/Zwart)	21.02.288.2	105 p

110 x 110 (Anthracite/Antraciet)	21.02.184.2	85 p
110 x 110 (Noir/Zwart)	21.02.284.2	85 p

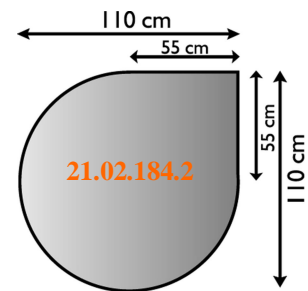
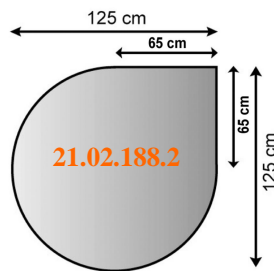
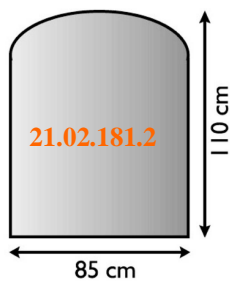

<u>DIMENSION / AFMETING</u>	<u>REFERENCE / REFERENTIE</u>	<u>PRIX / PRIJS (Htva/Excl. Btw)</u>
125 x 125 (Anthracite/Antraciet)	21.02.187.2	115 p
125 x 125 (Noir/Zwart)	21.02.287.2	115 p

120 x 105 (Anthracite/Antraciet)	21.02.183.2	85 p
120 x 105 (Noir/Zwart)	21.02.283.2	85 p

100 x 120 (Anthracite/Antraciet)	21.02.189.2	105 p
100 x 120 (Noir/Zwart)	21.02.289.2	105 p

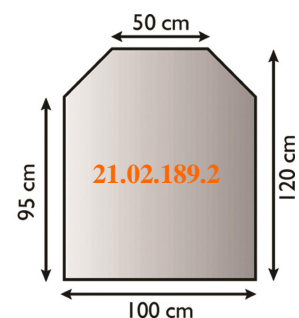
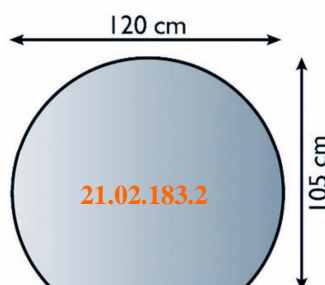
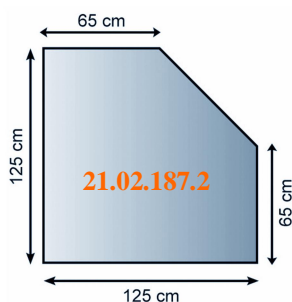

PLAQUE DE SOL ACIER 1.5 MM (EPOXY ANTHRACITE / EPOXY NOIR)

BESCHERMINGSPLAAT 1.5 MM (antraciet epoxy / zwart epoxy)

<u>DIMENSION / AFMETING</u>	<u>REFERENCE / REFERENTIE</u>	<u>PRIX / PRIJS (Htva/Excl. Btw)</u>
90 x 75 (Anthracite/Antraciet)	21.02.185.2	59 p
90 x 75 (Noir/Zwart)	21.02.285.2	59 p

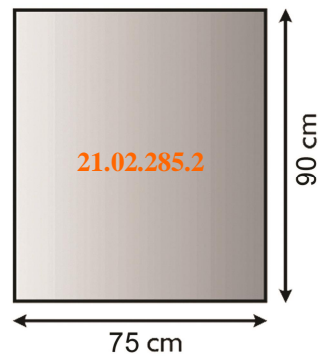
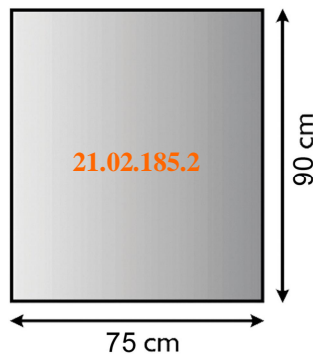

PLAQUE DE SOL EN VERRE 8 mm NOIR

BESCHERMINGSPLAAT IN GLAS 8 mm ZWART

<u>DIMENSION / AFMETING</u>	<u>REFERENCE / REFERENTIE</u>	<u>PRIX / PRIJS (Htva/Excl. Btw)</u>
100 x 120 (Noir/Zwart)	21.02.851.2	125 p
110 x 110 (Noir/Zwart)	21.02.853.2	135 p
100 x 120 (Noir/Zwart)	21.02.852	115 p

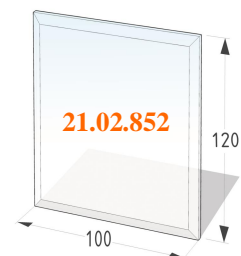
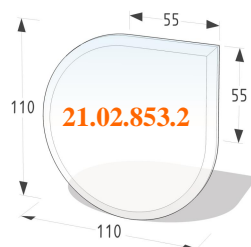

SERVITEUR - ACCESSOIRES

HAARDSTEL—ACCESSOIRES

<u>DESCRIPTION/ BESCHRIJVING</u>	<u>REFERENCE / REFERENTIE</u>	<u>PRIX / PRIJS (Htva/Excl. Btw)</u>
Serviteur Inox en verre trempé Inox haardstel in gehard glas	21.02.492.2	125 p
Serviteur Inox en verre trempé Inox haardstel in gehard glas	21.02.493.2	110 p
Serviteur Inox en verre trempé Inox haardstel in gehard glas	21.02.497.2	95 p



<u>DESCRIPTION/ BESCHRIJVING</u>	<u>REFERENCE / REFERENTIE</u>	<u>PRIX / PRIJS (Htva/Excl. Btw)</u>
Serviteur Anthracite, poignées bois Antraciet haardstel met houten handgreep	21.02.711.2	59 p
Serviteur Anthracite, poignées bois Antraciet haardstel met houten handgreep	21.02.741.2	35 p
Serviteur Anthracite, poignées bois Antraciet haardstel met houten handgreep	21.02.243.2	50 p



SERVITEUR - ACCESSOIRES

HAARDSTEL—ACCESSOIRES

<u>DESCRIPTION/ BESCHRIJVING</u>	<u>REFERENCE / REFERENTIE</u>	<u>PRIX / PRIJS (Htva/Excl. Btw)</u>
Serviteur epoxy anthracite Antraciet haarstel in epoxy	21.02.313.2	120 p
Serviteur epoxy anthracite Antraciet haarstel in epoxy	21.02.273.2	130 p
Serviteur epoxy anthracite Antraciet haarstel in epoxy	21.02.226.2	140 p

21.02.313.2



21.02.273.2

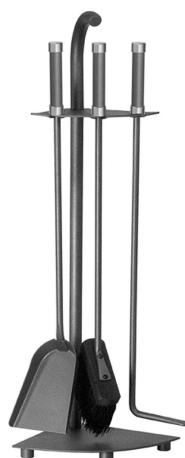

21.02.226.2



<u>DESCRIPTION/ BESCHRIJVING</u>	<u>REFERENCE / REFERENTIE</u>	<u>PRIX / PRIJS (Htva/Excl. Btw)</u>
Serviteur epoxy anthracite poignées Inox Antraciet haardstel in epoxy (met inox handgrepen)	21.02.327.2	225 p
Serviteur epoxy anthracite poignées Inox Antraciet haardstel in epoxy (met inox handgrepen)	21.02.306.2	150 p
Serviteur epoxy anthracite poignées Inox Antraciet haardstel in epoxy (met inox handgrepen)	21.02.643.2	95 p

21.02.327.2



21.02.306.2



21.02.643.2



SERVITEUR - ACCESSOIRES

HAARDSTEL—ACCESSOIRES

<u>DESCRIPTION/ BESCHRIJVING</u>	<u>REFERENCE / REFERENTIE</u>	<u>PRIX / PRIJS (Htva/Excl. Btw)</u>
Serviteur époxy noir accessoires Poignées Bois (37/67/37) Zwart haardstel in epoxy met houten handgreepô accessoires	21.02.220.2	180 p
Serviteur époxy noir accessoires Poignées Inox (30/32/26) Zwart haardstel in epoxy met inox handgreepô accessoires	21.02.966.2	175 p
Serviteur époxy noir accessoires Poignées Inox Zwart haardstel in epoxy met inox handgreepô accessoires	21.02.441.2	155 p

21.02.220.2



21.02.966.2



21.02.441.2



<u>DESCRIPTION/ BESCHRIJVING</u>	<u>REFERENCE / REFERENTIE</u>	<u>PRIX / PRIJS (Htva/Excl. Btw)</u>
Serviteur époxy noir accessoires Poignées Inox Zwart haardstel in epoxy met inox handgreepô accessoires	21.02.706.2	30 p
Serviteur époxy noir accessoires Poignées Inox Zwart haardstel in epoxy met inox handgreepô accessoires	21.02.740.2	40 p
Serviteur époxy noir accessoires Poignées Inox Zwart haardstel in epoxy met inox handgreepô accessoires	21.02.904.2	95 p

21.02.706.2



21.02.740.2



21.02.904.2



PARE-FEU

HAARDSCHERM

<u>DESCRIPTION/ BESCHRIJVING</u>	<u>REFERENCE / REFERENTIE</u>	<u>PRIX / PRIJS (Htva/Excl. Btw)</u>
Pare-Feu (20 x 60 x 20) / Haardscherm	21.05.025.2	45 p
Pare-Feu (80 x 55) / Haardscherm	21.05.026.2	40 p
Pare-Feu / Haardscherm	21.02.763.2	125 p

21.05.025.2



21.05.026.2



21.02.763.2



<u>DESCRIPTION/ BESCHRIJVING</u>	<u>REFERENCE / REFERENTIE</u>	<u>PRIX / PRIJS (Htva/Excl. Btw)</u>
Pare-Feu / Haardscherm	21.05.005.2	85 p
Pare-Feu (48x 105 x 48) / Haardscherm	21.02.205.2	110 p
Pare-Feu (112 x 84 x 74) / Haardscherm	21.02.440.2	95 p

21.05.005.2



21.02.205.2



21.02.440.2



PANIER A BOIS - CHARBONNIERE

HOUTMANDEN - KOLENGIETER

<u>DESCRIPTION/ BESCHRIJVING</u>	<u>REFERENCE / REFERENTIE</u>	<u>PRIX / PRIJS (Htva/Excl. Btw)</u>
Panier à bois époxy noir / Zwart epoxy houtmanden	21.00.242.2	160 p
Panier à bois en cuir régénéré / Leder houtmanden	21.02.766.2	215 p
Panier à bois époxy noir (40kg)/ Zwart epoxy houtman- den	21.00.240.2	250 p
Panier à bois époxy noir (80kg) Zwart epoxy houtmanden	21.00.241.2	299 p

21.00.242.2



21.02.766.2



21.00.240.2



21.00.241.2



<u>DESCRIPTION/ BESCHRIJVING</u>	<u>REFERENCE / REFERENTIE</u>	<u>PRIX / PRIJS (Htva/Excl. Btw)</u>
Charbonnière / Kolengieter	21.02.350.2	35 p
Charbonnière / Kolengieter	21.02.352.2	25 p
Charbonnière / Kolengieter (10l)	21.02.353.2	20 p

21.02.350.2



21.02.352.2



21.02.353.2



PANIER

HOUTMANDEN

<u>DESCRIPTION/ BESCHRIJVING</u>	<u>REFERENCE / REFERENTIE</u>	<u>PRIX / PRIJS (Htva/Excl. Btw)</u>
Panier en cuir pour bois (54/42/35)/ Leder houtmanden	21.02.660.2	130 p
Panier en simili-cuir pour bois / Houtmand in kunstleder	21.02.665.2	65 p
Seau à Charbon noir / Zwarte emmer voor steenkool	21.06.069.0	45 p

21.02.660.2



21.02.665.2



21.06.069.2



<u>DESCRIPTION/ BESCHRIJVING</u>	<u>REFERENCE / REFERENTIE</u>	<u>PRIX / PRIJS (Htva/Excl. Btw)</u>
Panier en feutre noir pour bois / Houtmand in zwarte vilt	21.02.668.2	50 p
Panier en feutre gris pour bois / Houtmand in grijze vilt	21.02.667.2	55 p
Panier en feutre rouge pour bois / Houtmand in rode vilt	21.02.664.0	99 p

21.02.668.2



21.02.667.2



21.02.664.0



<u>DESCRIPTION/ BESCHRIJVING</u>	<u>REFERENCE / REFERENTIE</u>	<u>PRIX / PRIJS (Htva/Excl. Btw)</u>
Panier en feutre rouge pour bois / Houtmand in rode vilt (39 x31)	21.02.662.2	110 p
Panier en feutre gris pour bois / Houtmand in grijze vilt (39 x 31)	21.02.663.2	110 p
Panier à bois Anthracite / Antra- ciet houtmand	21.02.270.2	95 p

21.02.662.2



21.02.663.2



21.02.270.2



PELLE - SEAU A CENDRE

SCHEP—ASEMMERS

<u>DESCRIPTION/ BESCHRIJVING</u>	<u>REFERENCE / REFERENTIE</u>	<u>PRIX / PRIJS (Htva/Excl. Btw)</u>
Pelle époxy noir / Zwarte schep in epoxy	21.02.419.2	25 p
Pelle aluminium / Aluminium schep	21.02.421.2	15 p
Pelle plastic / plastic schep	30.76.020.1	10 p



<u>DESCRIPTION/ BESCHRIJVING</u>	<u>REFERENCE / REFERENTIE</u>	<u>PRIX / PRIJS (Htva/Excl. Btw)</u>
Seau à cendre galva 15L / Gegalva- niseerde asemmer	21.02.452.2	19 p
Seau à cendre galva 24L / Gegalva- niseerde asemmer	21.02.453.2	21 p
Seau à cendre anthracite 15L/ An- traciet asemmer 15L	21.02.462.2	25 p
Seau à cendre anthracite 24L / An- traciet asemmer 24l	21.02.463.2	30 p

21.02.452.2



21.02.462.2



BOUILLOIRE - SATURATEUR - ASPIRATEUR - COMBUSTIBLE

KOKER—SATURATEUR—STOFZUIGER—BRANDSTOF

<u>DESCRIPTION/ BESCHRIJVING</u>	<u>REFERENCE / REFERENTIE</u>	<u>PRIX / PRIJS (Htva/Excl. Btw)</u>
Bouilloire Vapeur grise / Grijsze stoomketel	21.06.064.0	70 p
Saturateur inox / Inox saturateur	21.02.850.0	45 p
Saturateur céramique / Keramische saturateur	21.02.845.0	25 p

21.06.064.0



21.02.850.0



21.02.845.0

<u>DESCRIPTION/ BESCHRIJVING</u>	<u>REFERENCE / REFERENTIE</u>	<u>PRIX / PRIJS (Htva/Excl. Btw)</u>
Vide cendre avec moteur / Gemotoriseerde aslediger	21.06.090.0	75 p
Dynamit Briquet	21.06.070.0	65 p
Allume-feu Cire bois (80 ballotins/Cartron) (1 Kg) / Houten aanmaakblokjes (80 stuks/verpakking)	21.06.045.0	10 p

21.06.090.0



21.06.070.0



21.06.045.0



Eponges / Sponzen	21.06.042.0	10 p
Grandes Allumettes / Grote lucifers	21.06.024.0	4 p
Allume feu Barbecue (2 Kg) / BBQ aanmaakblokjes	21.06.054.0	20 p

21.06.042.0



21.06.024.0



21.06.054.0





LIENBACHER

By **J.P. VOS** 
HI THERM PRODUCTS S.P.R.L.

Votre Revendeur / uw dealer

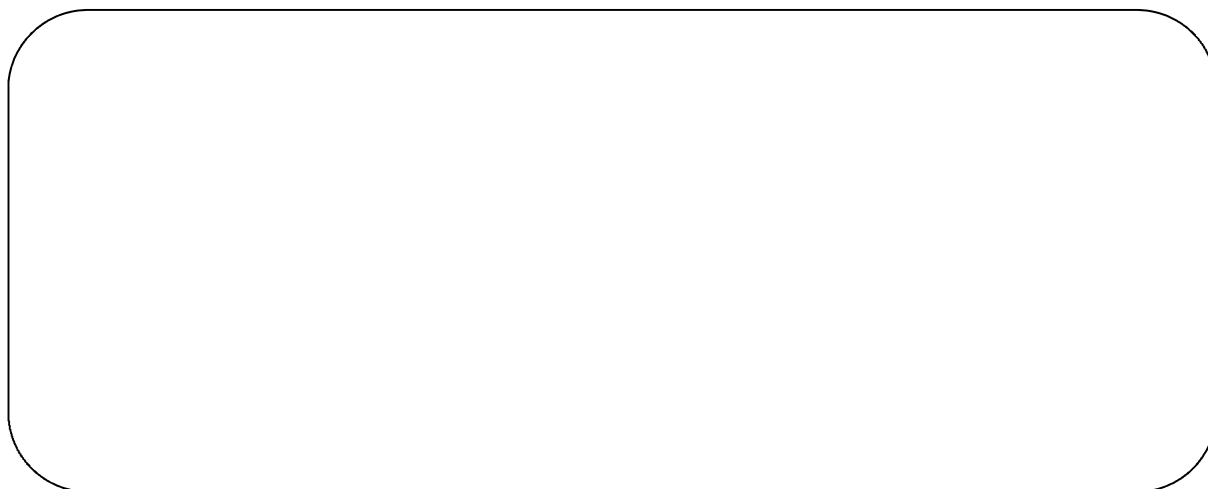

new website : www.jpvos.be - Follow us on



